

Symaro™

Duct Temperature Sensors QAM21...

Passive sensors for acquiring the air temperature in air ducts.

Use

The duct temperature sensors are for use in ventilation and air conditioning plants as:

- Supply or extract air temperature sensors
- Limit sensors, e.g. for minimum limitation of the supply air temperature
- Reference sensors, e.g. for shifting the room temperature as a function of the outside temperature
- Measuring sensors, e.g. for measured value indication or for connection to a building automation and control system

Type summary

Type reference	Probe length	Mounting clamps	Sensing element
QAM2110.040	0,4 m	no	Pt 100
QAM2112.040	0,4 m	no	Pt 1000
QAM2112.200	2,0 m	4 pcs.	Pt 1000
QAM2120.040	0,4 m	no	LG-Ni 1000
QAM2120.200	2,0 m	4 pcs.	LG-Ni 1000
QAM2120.600	6,0 m	6 pcs	LG-Ni 1000
QAM2130.040	0,4 m	no	NTC 10k

Accessories
(Spare parts)

Name	Type reference
Capillary tube clamp for the QAM2120.200 and QAM2120.600 (6 pieces)	AQM63.3
Mounting flange	AQM63.0

Ordering and delivery

When ordering, please give name and type reference, e.g.:

Duct temperature sensor **QAM2120.040**

The sensor is supplied complete with mounting flange AQM63.0 and, if required, mounting clamps AQM63.3.

Equipment combinations

All systems or devices capable of acquiring and handling the sensor's passive output signal.

Function

The sensor acquires the air temperature via its sensing element whose resistance changes as a function of the temperature. The signal is delivered to a suitable controller for further handling.

Sensing elements

LG-Ni 1000

Characteristic:

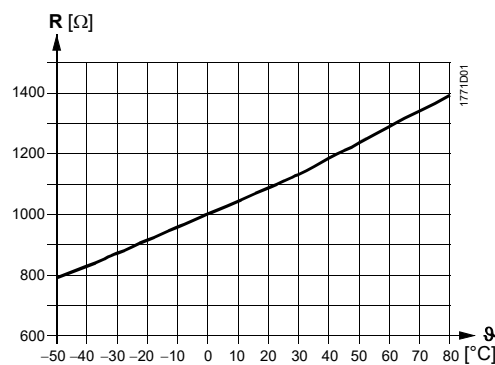

Accuracy:

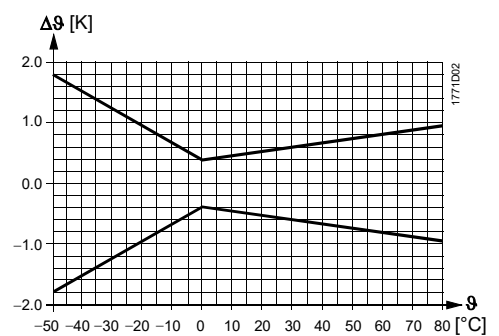

Pt 100 (class B)

Characteristic:

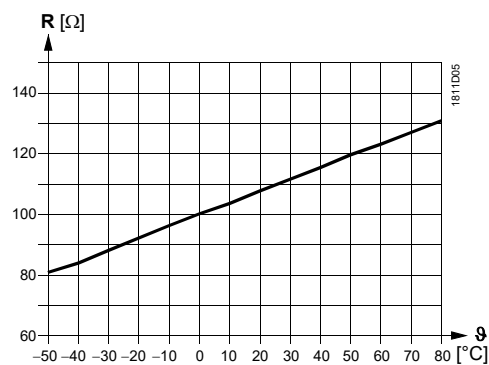

Accuracy:

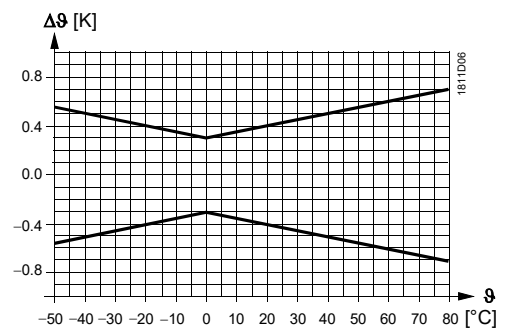

Pt 1000 (class B)

Characteristic:

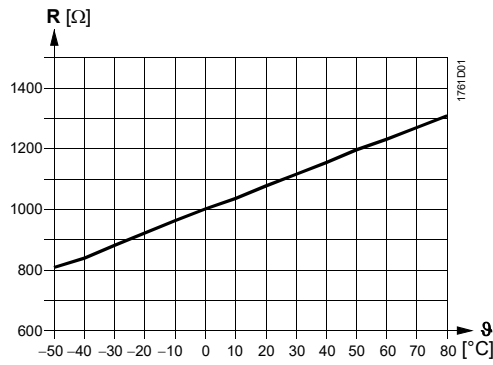

Accuracy:

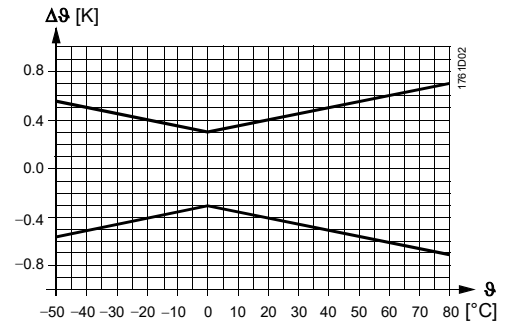

NTC 10k

Characteristic:

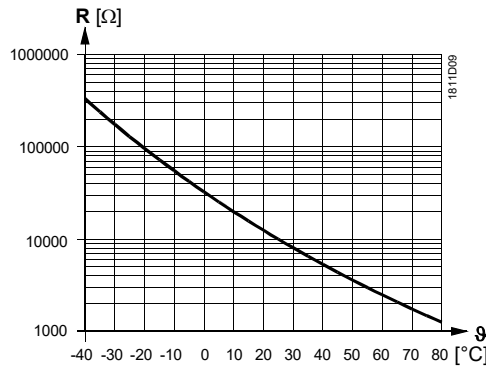

Accuracy:

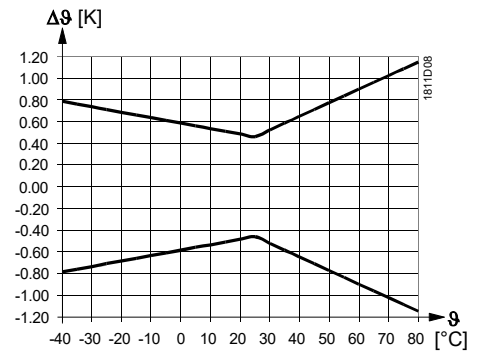

Legend

- R Resistance value in Ohm
- θ Temperature in degrees Celsius
- Δθ Temperature differential in Kelvin

Mechanical design

The duct temperature sensor consists of the following components:

- Two-sectional plastic housing comprised of base with connection terminals and removable cover (snap-on design)
- Fully active, flexible probe with sensing element which acquires the average temperature

The connection terminals can be accessed after removing the cover. Cable entry is made via a grommet which, if required, can be replaced by a cable entry gland M16 (IP 54).

After fitting the mounting flange, the sensor can be installed in 6 different immersion positions so that the sensor housing is always located outside the insulation for layers up to 70 mm. The probe with a length of 2 or 6 m is to be fitted across the air duct with the help of the mounting clamps supplied with the sensor.

Mounting notes

Mounting location

- *For supply air temperature control:* Downstream from the fan, if the fan is located after the last air handling unit. Otherwise, after the last air handling unit with a minimum distance of 0.5 m
- *For extract air temperature control:* Always upstream of the extract air fan
- *As a limit sensor for the supply air temperature:* As close as possible to the air outlet into the room
- *For dew point control:* Immediately after the spray trap of the air washer

Manually bend the probe so that it lies diagonally across the duct or in equally spaced windings across the entire duct cross-section. The probe must not touch the duct wall.

The sensor is supplied complete with Mounting Instructions.

Mounting positions

permitted:



not permitted:



Mounting examples

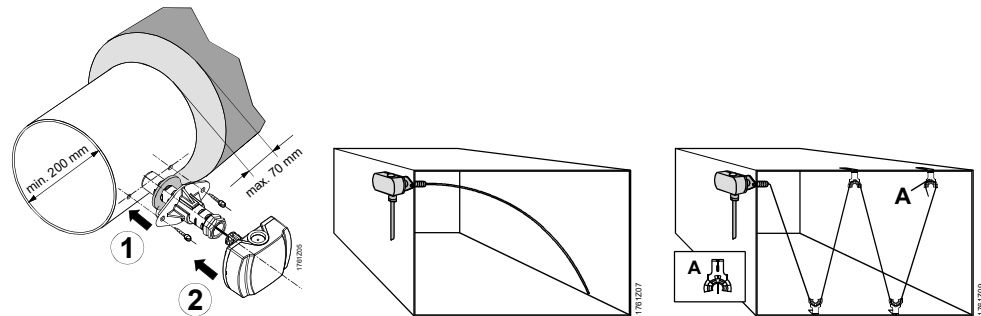

Disposal



This symbol or any other national label indicate that the product, its packaging, and, where applicable, any batteries may not be disposed of as domestic waste. Delete all personal data and dispose of the item(s) at separate collection and recycling facilities in accordance with local and national legislation.

For additional details, refer to www.siemens.com/bt/disposal.

Technical data

Functional data	Operating range	-40...+80 °C for NTC type -50...+80 °C other types
	Sensing element	refer to "Type summary"
	Probe	
	Length	Refer to "Type summary"
	Min. bending radius	10 mm
	Time constant	30 s at 2 m/s
	Dead time	< 1 s
Degree of protection	Measuring accuracy	Refer to "Function"
	Protection class	III according to EN 60730-1
	Protection degree of housing With cable entry gland M 16 x 1.5	IP42 according to EN 60529 IP54 according to EN 60529 (not included as standard)
Electrical connections	Screw terminals for	1 x 2.5 mm ² or 2 x 1.5 mm ²
	Cable entry	
	Grommet	For 5.5...7.2 mm dia. cable
	Cable entry gland	M 16 x 1.5 can be fitted
Directives and Standards	Perm. cable lengths	refer to Data Sheet of the relevant controller
	Product standard	EN 60730-1 Automatic electrical controls for household and similar use
	UL	UL 873, http://ul.com/database
	EU Conformity (CE)	CE1T1761xx *)
	Environmental conditions	Operation
Climatic conditions		class 3K5
Temperature (housing)		-40...+70 °C
Humidity (housing)		5...95 % r. h.
Transport		To IEC 60721-3-2
Climatic conditions		Class 2K3
Temperature	-25...+70 °C	
Humidity	<95 % r. h.	
Mechanical conditions	class 2M2	
Materials and colors	Probe	Copper, polyolefine
	Base	Polycarbonate, RAL 7001 (silver-grey)
	Cover	Polycarbonate, RAL 7035 (light-grey)
	Mounting flange	PA 66 (black)
	Clamps	PA-GF 35 (black)
Weight	Packaging	Corrugated cardboard
	Incl. packaging	
	QAM2110.040	Ca. 0,15 kg
	QAM2112.040	Ca. 0,15 kg
	QAM2112.200	Ca. 0,3 kg
	QAM2120.040	Ca. 0,15 kg
	QAM2120.200	Ca. 0,30 kg
	QAM2120.600	Ca. 0,53 kg
QAM2130.040	Ca. 0,15 kg	

*) The documents can be downloaded from <http://siemens.com/bt/download>.

Internal diagram

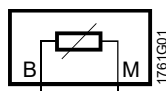

The internal diagram is identical for all types of duct temperature sensors covered by this Data Sheet.

The connecting wires are interchangeable.

Dimensions

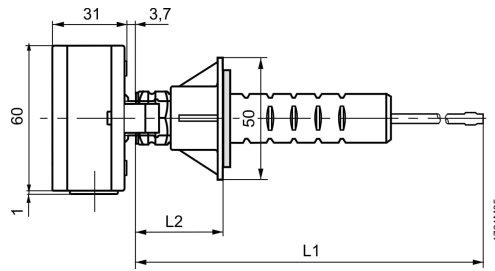
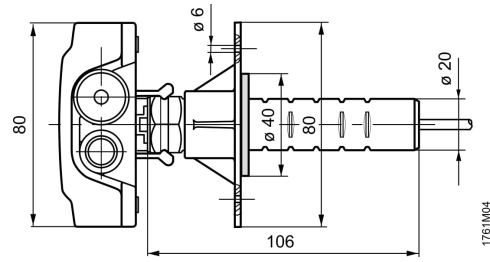

Typ	L1	L2	
		max.	min.
QAM2130.040	400	97	37
QAM2110.040	400	97	37
QAM2120.040	400	97	37
QAM2112.040	400	97	37
QAM2112.200	2000	97	37
QAM2120.200	2000	97	37
QAM2120.600	6000	97	37

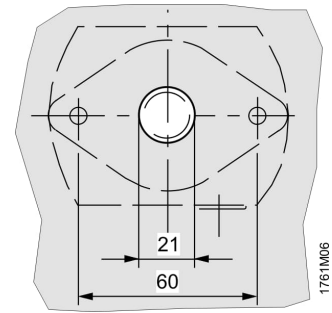

Drilling plan

Dimensions in mm

Issued by:
 Siemens Switzerland Ltd.
 Smart Infrastructure
 Global Headquarters
 Theilerstrasse 1a
 CH-6300 Zug
 Tel. +41 58 724 2424
www.siemens.com/buildingtechnologies

© Siemens 2004
 Technical specifications and availability subject to change without notice.