

## Touch Screen Flush-Mounted PM2.5 & IAQ Controllers With KNX or RS485 Modbus

RDF870KN.. and RDF870MB..



### PM2.5 control, CO2 control, or both and ventilation applications

RDF870KN (KNX) and RDF870MB (Modbus) controllers:

- AC 230 V operating voltage, large, backlit display
- Display and setpoint adjustment for PM2.5 and CO<sub>2</sub> control
- Display of room temperature, outside temperature, VOC (volatile organic compound) and r.h. (relative humidity)
- Supports 1-/3-/4-speed On/Off fan or DC fan output
- Two multifunctional inputs for external passive and DC 0...10 V sensors
- Operating modes: Comfort, Economy and Protection
- KNX S-Mode for RDF870KN
- KNX commissioning via ETS or local control parameters
- KNX integration into Desigo via group (ETS) or individual addressing
- KNX integration into third-party system via group addressing (ETS)
- RS485 Modbus RTU slave mode for RDF870MB
- Modbus commissioning via third-party tool, e.g. Modbus scan, Modbus poll, etc.

RDF870MB can be configured as a room unit via DIP switches and it provides the following additional functions:

- Setpoint adjustment and display for room temperature, VOC, RH and display of outside temperature
- Four external outputs via bus and controlled by a master controller

Mounting on recessed square 86 mm box or round 60 mm with 60 mm fixing centers and minimum 40 mm depth

## Use

Ventilation control in purifier systems:

Typical applications:

- Residential apartments
- Commercial buildings
- Schools/Universities
- Hospitals/Healthcare centers

Local and remote configuration via one of the following:

- Local HMI
- DIP switch selection: room controller or room unit      RDF870MB only
- Third-party tool Modbus poll/Modbus scan              RDF870MB only
- ETS    RDF870KN only

## Functions

For room controllers

- Maintain PM2.5 or CO<sub>2</sub> level or both via controlling a fan of fresh air units or air purifiers
- Display of room temperature via built-in temperature sensor or bus
- Setpoint adjustment for PM2.5 and CO<sub>2</sub> only
- PM2.5 and CO<sub>2</sub> values are received from external sensor or via bus.
- CO<sub>2</sub> control has higher priority than PM2.5 control if both controls are available.

For room unit

- Display room temperature via built-in sensor in °C
- Display outside temperature via bus or outside sensor input in °C
- Display PM2.5 via bus or outside sensor input in µg/m<sup>3</sup>
- Display CO<sub>2</sub> via bus or outside sensor input in ppm
- Display VOC via bus or outside sensor input in mg/m<sup>3</sup> or %
- Display relative humidity via bus or outside sensor input in % r.h.
- Setpoint adjustments for all of the above

Common functionalities

- Selection of operating modes
- Minimum and maximum setpoint limitation
- Fan speed adjustment: Auto, manual (up to 4 speeds)
- Reload factory settings for commissioning, engineering mode and control parameters

## Mechanical design

The room controller/room unit consists of the following parts:

- Front panel with electronics, operating elements and built-in room temperature sensor
- Mounting base with power electronics
- Mounting frame is an additional part to complete the installation for RDF870...

Operation





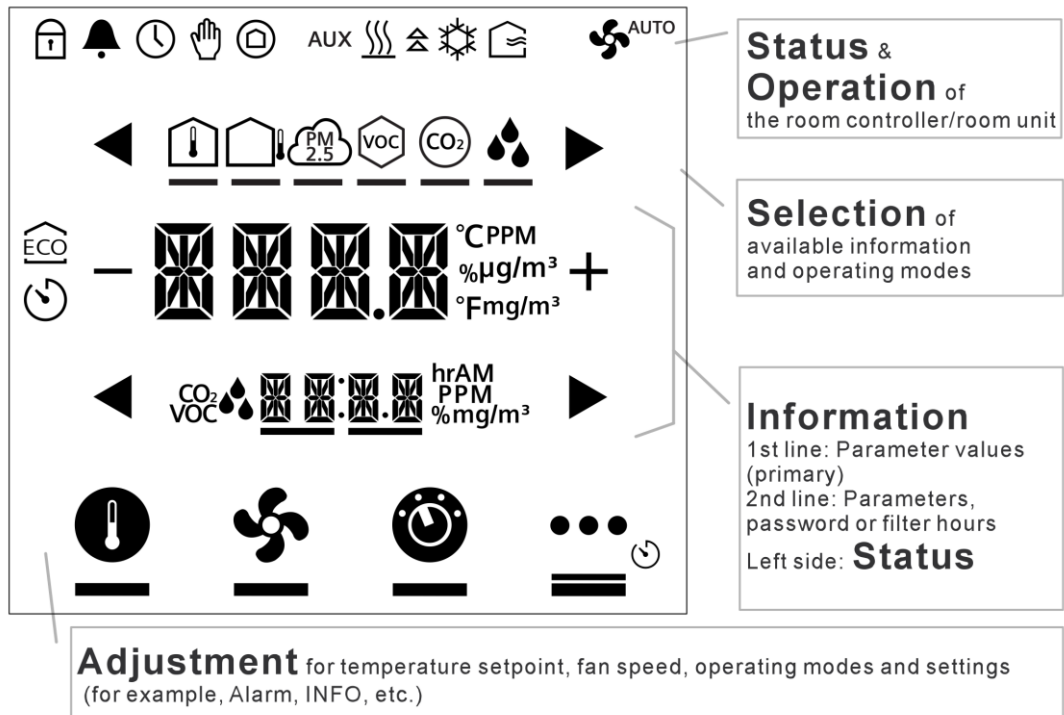





Display



Status symbols			
	Screen lock		Heating mode
	Alarm/service reminder		Valve on
	Manual override		Cooling mode
	Protection mode		Ventilation mode
	Auxiliary heating active		Auto fan mode
	Economy mode		Timer

Selection symbols			
	Room temperature		VOC mode
	Outdoor temperature		CO2 mode
	PM2.5 mode		Relative humidity

Operational icons	
	Increment, decrement or selection
	Selection, change or move to previous or next items
	Display values, relative humidity or parameter values, etc.
	Secondary display, parameters, password / filter hours
	Setpoint mode
	Fan mode or fan speed mode
	Operating mode
	More functions or info

## Type summary

Product no.	Stock no.	Operating voltage	Control outputs		Suitable for
			On/Off	DC 0...10 V	
RDF870KN	S55770-T407	AC 230 V	4 <sup>1)</sup>	1	Square or round conduit box
RDF870MB	S55770-T408	AC 230 V	4 <sup>1)</sup>	1	Square or round conduit box

<sup>1)</sup> On/Off output with potential free input from AC 230 V





## Ordering

- When ordering, indicate product number, SSN and name.  
e.g. RDF870KN (S55770-T407) room controller
- Order sensors separately.

## Equipment combinations

### Sensors

Type of units		Product number	Data sheet*)
Room sensor for detection of PM2.5 3-color LED service indication		QSA2700	A6V11160938
Room sensor with LCD display for detection of PM2.5 2.4-inch color LCD screen for PM2.5 values, air quality index, and service		QSA2700D	A6V11160938

Type of units		Product number	Data sheet*)
Duct air quality sensor CO <sub>2</sub> / temperature / rel. humidity / VOC		QPM1100, QPM2100, QPM2102	N1962
Duct air quality sensor CO <sub>2</sub> / temperature / rel. humidity / VOC		QPM2102D	N1962
Duct air quality sensor CO <sub>2</sub> / temperature / rel. humidity / VOC		QPM2160, QPM2180	N1962
Duct air quality sensor CO <sub>2</sub> / temperature / rel. humidity / VOC		QPM2160D, QPM2162D	N1962

\*) All documents can be downloaded from <https://www.downloads.siemens.com/download-center>.

## Product documentation

Title	Document ID:
Operating instruction	A6V11439451
CE declaration	A5W90010366 (RDF870KN) A5W90010367 (RDF870MB)
Environmental product declaration	A6V11625786

Related documents such as environmental declarations, CE declarations, etc., can also be downloaded at the following Internet address:

<http://siemens.com/bt/download>

## Notes

### Security

	<b>⚠ CAUTION</b>
	<p><b>National safety regulations</b></p> <p>Failure to comply with national safety regulations may result in personal injury and property damage.</p> <ul style="list-style-type: none"> <li>Observe national provisions and comply with the appropriate safety regulations.</li> </ul>

See the product documentation for information on engineering, selection and sizing connecting cables for supply voltage and field devices.

**Mounting and installation**

Mount the room controller on a conduit box. Do not mount on a wall in niches or between bookshelves, behind curtains, above or near heat sources, wind outlets or inlets, and do not expose to direct solar radiation. Mount about 1.5 m above the floor.

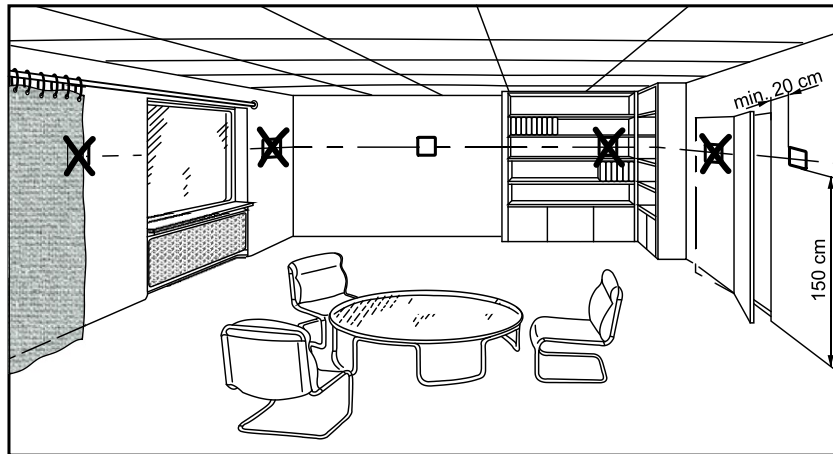

Mounting



- Do not apply excessive force to screws! Deformation of the mounting frame may result in improper connections and faulty operation.
- Mount the room controller in a clean, dry indoor place without direct airflow from a heating/cooling device, not exposed to drips or splash water.
- Before removing the front cover, disconnect the power supply.

	<p><b>⚠ WARNING</b></p>
	<p><b>No internal line protection for supply lines to external consumers</b>                  Risk of fire and injury due to short-circuits</p> <ul style="list-style-type: none"> <li>• Adapt the line diameters as per local regulations to the rated value of the installed fuse.</li> </ul>

Wiring



See Operating Instruction for the installation instructions enclosed with room controller.

- Comply with local regulations to wire, protect and earth the room controller.
- The device has no internal fuse for supply lines to fan and actuators. To avoid risk of fire and injury due to short-circuits, the AC 230 V mains supply line must have a circuit breaker with a rated current of no more than 10 A.
- The wiring cross section used for power supply (L, N) and 230 V outputs (Qxx - N) must be adapted to the preceding overload protection elements (max. 10 A) under all circumstances. Always comply with local regulations.
- Properly size the cables to the room controller and valve actuators for AC 230 V mains voltage.
- Cables of SELV inputs X1-M / X2-M: Use cables with min. 230 V insulation, as the conduit box carries AC 230 V mains voltage.
- Inputs X1-M or X2-M of different units (e.g. temperature sensor) may be connected in parallel with an external switch. Consider overall maximum contact sensing current for switch rating.
- KNX communication cables (input CE+ / CE-): Use cables with Min. 230 V insulation, as the conduit box carries AC 230 V mains voltage. (Only for RDF870KN)
- When a KNX bus power supply is connected on the line with communicating room controller and Synco controllers, the internal KNX power supply of the Synco controllers must be switched off. (Only for RDF870KN)

- Isolate the cables of Modbus communication input A+, B- and REF for 230 V. (Only for RDF870MB)
- No cables are provided with a metal shield.
- Disconnect from supply before opening the cover.

## Commissioning

After powering up, all LCD segments light up for about three seconds before the room controller enter its normal states.



Address and application can be downloaded via ETS by pressing and holding  for more than five seconds to enter programming mode. (Only for RDF870KN)

The room controller and room unit can be set via DIP switches. (Only for RDF870MB)

### DIP switch configuration

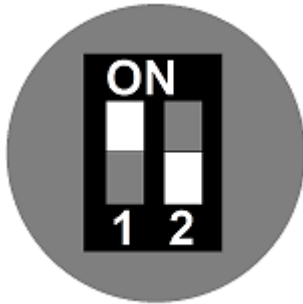

DIP switch positions		Application
1	2	
ON	OFF	Room unit
OFF	OFF	Room controller

DIP switch setting applies to RDF870MB only.

Current factory setting for PM2.5 control with 3 speed on/off fan application is as follows:

- APP= 1: PM2.5 control only
- DISP: Room temp= 1; PM2.5= 1
- SEN1= 3: PM2.5 (AI)  $\mu\text{g}/\text{m}^3$  (0...10 V)
- SEN2= 0: no function
- FAN= 3: 3 speed fan

## Software version (RDF870KN)

---

Two different software versions of RDF870KN are available:

- RDF870KN with software version (U101): Related ETS5 file (RDF870KN\_v1d0\_ETS5.knxprod)
- RDF870KN with software version (U103): Related ETS5 file (RDF870KN\_v1d1\_ETS5.knxprod)

The software version can be checked as follows:

- The software version relates to production date (DDMMYYYY) on the individual package label or printed on the rear of the product.  
E.g. "DDMMYYYY = 02062019" equals to "02 June 2019"
  - If YYYY = 2018, 2019 or 2020, RDF870KN software version is "U101".
  - IF YYYY = 2021 onwards, RDF870KN software version is "U103".
- Checked under parameter mode:
  - Enter password 9999 after accessing parameter mode. For parameter mode access, see Parameter mode user access [▶ 19].
  - When first parameter appears, press and hold ▶ until "SW" is displayed. Then related software version is shown as "U101" or "U103".

Note

For further support, please raise a support request via site:

<https://support.industry.siemens.com/cs>.

## Disposal

---



The device is considered an electronic device for disposal in accordance with the European Guidelines and may not be disposed of as domestic garbage.

- Dispose of the device through channels provided for this purpose.
- Comply with all local and currently applicable laws and regulations.

## Warranty

Technical data on specific applications are valid only together with Siemens products listed under "Equipment combinations". Siemens rejects any and all warranties in the event that third-party products are used.



Power supply	
Operating voltage	AC 230 V
Frequency	50/60 Hz.
Power consumption	Max. 7.0 VA / 2.5 W

	<p><b>⚠ CAUTION</b></p>
	<p><b>On internal fuse.</b> External preliminary line protection with max. C 10 A circuit breaker required in all cases.</p>

Multifunctional input X1-M/X2-M	
Temperature sensor input: Type Temperature range Accuracy Calibration range	NTC 10k 0...50 °C (32...122 °F) ±0.5 K at 25 °C (77 °F) -5 K...5 K, resolution 0.5 K
Digital Input: Logic states Insulation against mains voltage (SELV) Cable length	Selectable NO/NC ≥3.75 kV, reinforced insulation Up to 80 m (wire diameter of 1.5 mm <sup>2</sup> )
Analog input Signal type Sensor range and limit Cable length	0...10 V, NTC 10k Set by parameters Up to 80 m (wire diameter of 1.5 mm <sup>2</sup> )
Function of inputs PM2.5 sensor, CO <sub>2</sub> sensor, VOC sensor, humidity sensor, alarm input	Selectable X1: SEN1 X2: SEN2

Output	
3/4 speed fan Type Voltage Maximum current	Q1...Q4 On/Off AC 230 V 5(2) A
ECM fan Type Voltage Maximum current	Y50 Modulating DC 0...10 V 5.0 mA

	<p><b>⚠ CAUTION</b></p>
	<p>If fans must be connected in parallel, connect one fan directly, for additional fans, one relay for each speed.</p>

<b>KNX interface</b>	
KNX type Bus current	KNX TP1-64, galvanic isolation. 5 mA

<b>Modbus interface</b>	
Modbus type	RS485
Transmit mode	RTU
Connection	Support up to 32
Baud rate	9600, 19200 (default), 38400
Modbus address	1-247, 1 (default)
Cable length	Max. 1200 meters
Identity	Slave
Transmission format (start bit – data – parity – stop)	0 = 1-8-E-1 (default) / 1 = 1-8-O-1 / 2 = 1-8-N-1 / 3 = 1-8-N-2

<b>Wiring connections</b>	
Diameter Wire	1.5 mm <sup>2</sup> Solid or stranded

<b>Ambient conditions and protection classification</b>	
Classification as per EN 60730	
Function of automatic control devices	Type 1
Degree of contamination	2
Overvoltage category	III
Design type	Device suited for use with equipment of safety class II.
Degree of protection of housing to EN 60529	
Room automation station	IP30.
With terminal cover	IP30.
Climatic ambient conditions	
Transport (packaged for transport) as per EN 60721-3-2	Class 2K3
Operation as per EN 60721-3-3.	Class 3K5 <sup>1)</sup>
Mechanical ambient conditions	
Transport as per EN 60721-3-2	Class 2M2.
Operation as per EN 60721-3-3	Class 3M2.

<sup>1)</sup> No condensation is allowed.

<b>Standards, directives and approvals</b>	
Electromagnetic compatibility	For residential, commercial, and industrial environments
EU conformity (CE)	A5W90010366 (RDF870KN) *) A5W90010367 (RDF870MB) *)

<b>Standards, directives and approvals</b>	
RCM conformity	A5W90010386 (RDF870KN) *) A5W90010387 (RDF870MB) *)
REACH	Regulation (EC) No 1907/2006 Registration, Evaluation, Authorisation and Restriction of Chemicals (REACH)
RoHS	Directive 2011/65/EU restriction of the use of certain hazardous substances in electronic equipment
Environmental compatibility	The product environmental declaration (A6V11625786 *) contains data on environmentally compatible product design and assessments (RoHS compliance, materials composition, packaging, environmental benefit, disposal).

<b>General</b>	
Weight without/with package	165 g / 265 g
Housing front color	Ivory white
Housing flammability class according to UL94	V-0

\*) The documents can be downloaded from <http://siemens.com/bt/download>.

Connection terminals

RDF870KN		RDF870MB	
X1	Multifunction input 1		
M	Input reference ground for X1, X2 and Y50		
X2	Multifunction input 2		
Y50	DC 0...10 V output		
CE+, CE-	KNX bus + and - terminals		
REF	Modbus reference ground		
A+, B-	Modbus + and - terminals		
L, N	AC 230 V operating voltage		
Q1	Output, fan speed 1, AC 230 V		
Q2	Output, fan speed 2, AC 230 V		
Q3	Output, fan speed 3, AC 230 V		
Q4	Output, fan speed 4, AC 230 V		

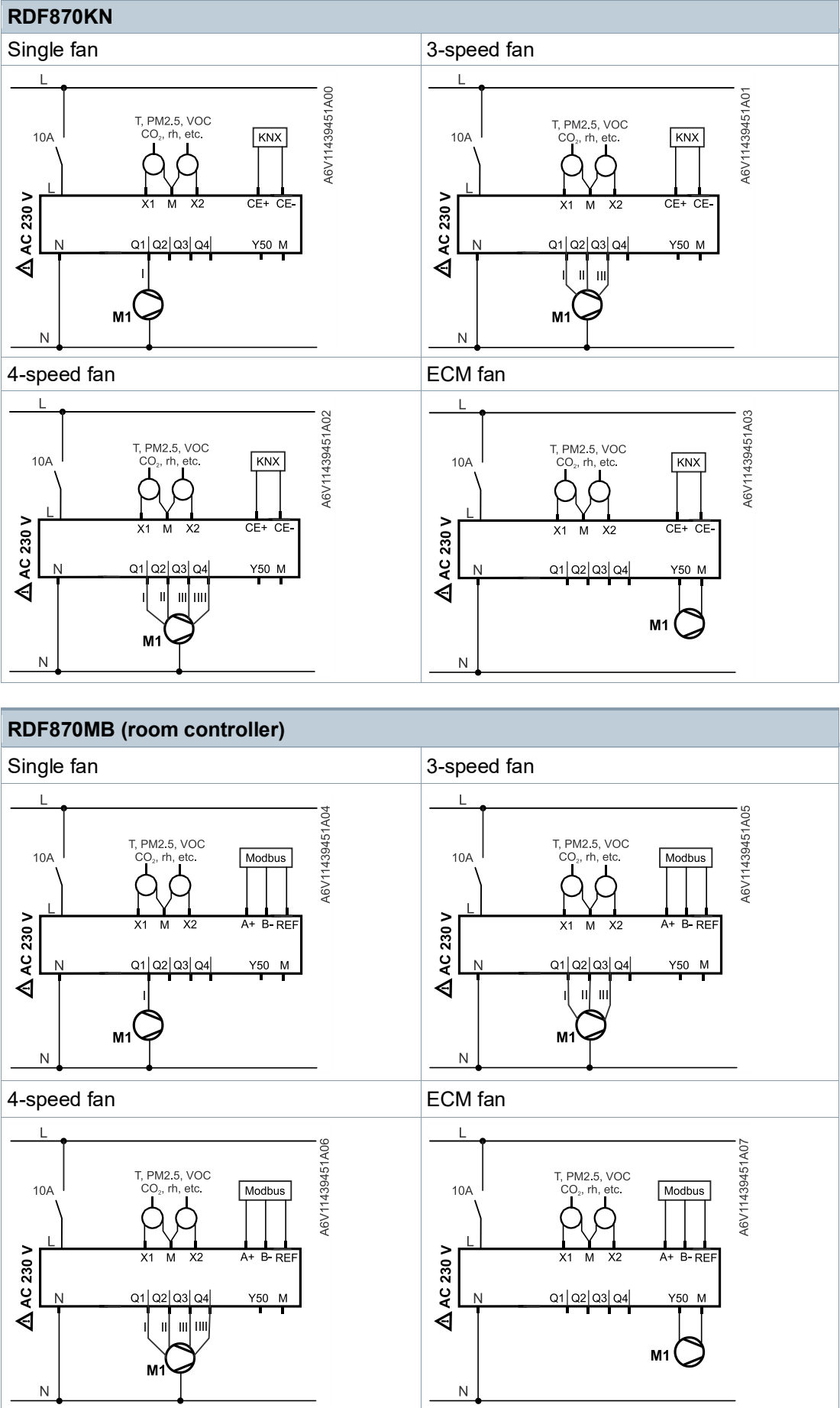

## RDF870MB (room unit)

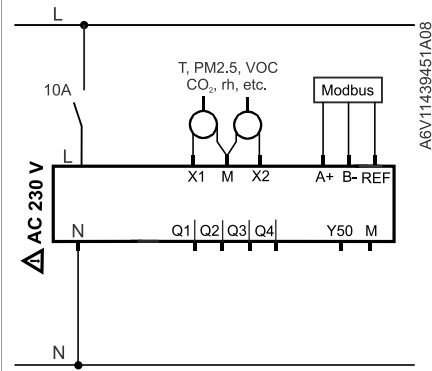

L, N	AC 230 V operating voltage
X1, X2	Multifunctional inputs 1 & 2 (sensor, alarm, etc.)
M	Input reference ground for X1, X2 and Y50
CE+, CE-	KNX bus + and - terminals
Q1, Q2, Q3, Q4	Four speeds fan output (relay output)
Y50	DC 0...10 V output
REF	Modbus reference ground
A+, B-	Modbus + and - terminals
M1	1-speed, 3-speed or 4-speed fan, DC 0...10 V fan

## Application examples

### CO<sub>2</sub> application (single duct single fan)

Single duct single fan fresh air unit or purifier with built-in PM2.5 filter

**Basic parameter settings: APP = 3, DISP (CO<sub>2</sub> = 1), SEN1 =4, FAN =1-/3-/4-speed on/off fan or ECM fan**

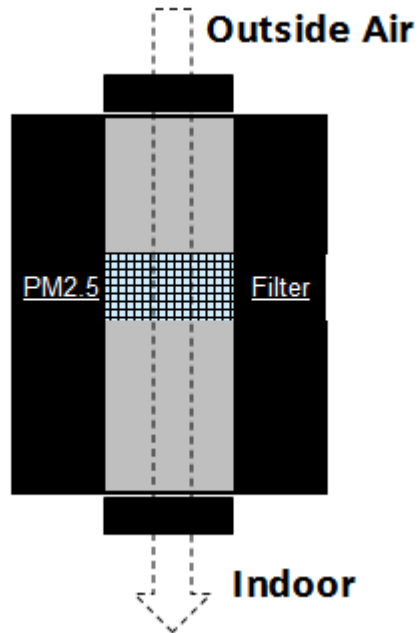

RDF870... unit can be set up as a CO<sub>2</sub> controller with an external CO<sub>2</sub> sensor connected to X1 to control the fan for a fresh air unit (i.e. single duct single fan fresh air unit with/without PM2.5 built-in filter).

The fan speeds are switched as per the actual CO<sub>2</sub> level and the CO<sub>2</sub> setpoint.

The built-in PM2.5 filter already purifies the outside air before entering indoors.

## PM2.5 application (single duct single fan)

Single duct single fan purifier with built-in PM2.5 filter

**Basic parameter settings: APP = 1, DISP (PM2.5 = 1), SEN1 =3, FAN =1-/3-/4-speed on/off fan or ECM fan**

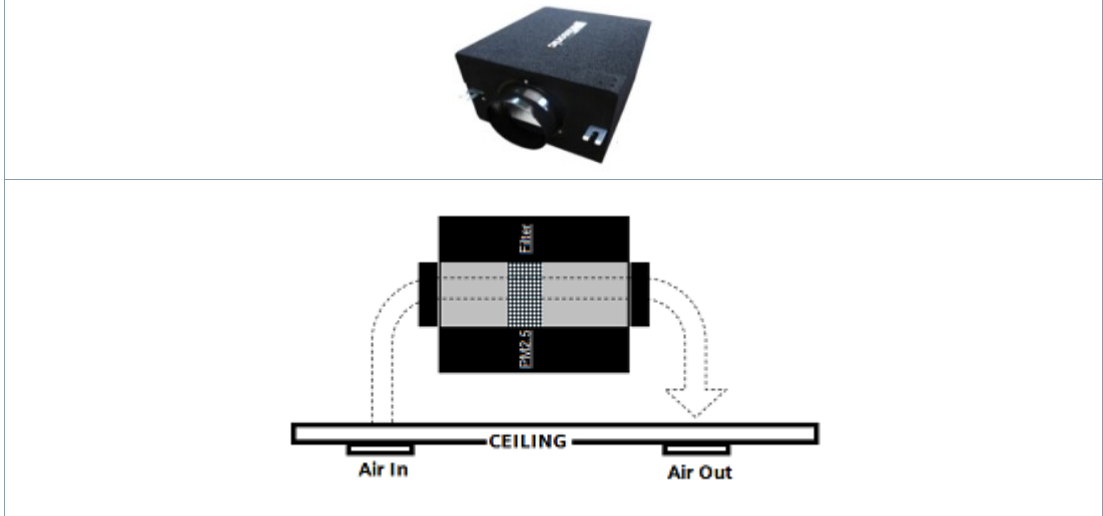

RDF870... unit can be set up as a PM2.5 controller with an external PM2.5 sensor connected to X1 to control the fan for a PM2.5 purifier unit (i.e. single duct single fan purifier with PM2.5 built-in filter).

The purifier is not connected to external but installed on the ceiling. The purifier circulates in-door through its built-in PM2.5 filter. The fan speeds are switched as per the actual PM2.5 level and the PM2.5 setpoint.



## CO2 application (dual duct parallel connected fan)

Dual duct parallel connected fan fresh air unit or purifier with built-in PM2.5 filter

**Basic parameter settings: APP = 3, DISP (CO<sub>2</sub> = 1), SEN1 =4, FAN =1-/3-/4-speed on/off fan or ECM fan**

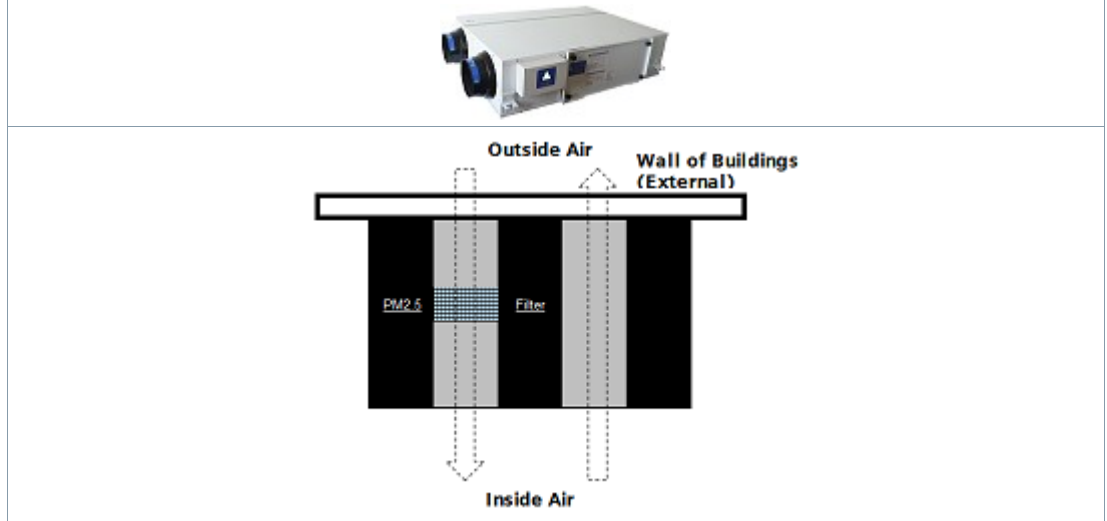

RDF870... unit can be set up as a CO<sub>2</sub> controller with an external CO<sub>2</sub> sensor connected to X1 to control the fan operation of a fresh air unit (i.e. dual duct parallel connected fan fresh air unit with/without PM2.5 built-in filter).

The fan speeds are switched as per the actual CO<sub>2</sub> value and the CO<sub>2</sub> setpoint.

The built-in PM2.5 filter already purifies the outside air before entering indoors.

This fresh air unit operates in similar way as per single duct type. With the dual duct type, air exchange performance is better.



### **⚠ CAUTION**

If fans must be connected in parallel, connect one fan directly, for additional fans, one relay for each speed.

## PM2.5 & CO2 room unit application (dual duct independent fan control together with a master controller)

Dual duct independent fan fresh air unit or purifier with built-in PM2.5 filter via by-pass damper

**Basic parameter settings: APP = 2, DISP (PM2.5 = 1, CO<sub>2</sub> = 1), SEN1 = 3, SEN2 = 4, FAN1 & FAN2 = 1-/3-speed on/off fan**

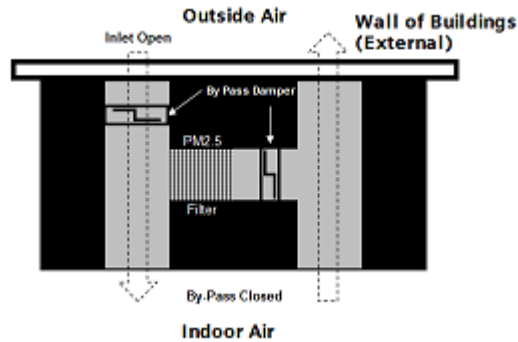

RDF870... unit can be set up as a controller combining PM2.5 and CO<sub>2</sub> control with an external PM2.5 and CO<sub>2</sub> sensors connected to X1 and X2 respectively to control the fan for a fresh air unit and purifier (i.e. dual duct independent fan fresh air unit with PM2.5 built-in filter via by-pass damper). The damper can be disabled (inlet open and by-pass close) or enabled (by-pass open) via an extra damper input from a master controller.

When the by-pass damper is inactive, the outside air can enter the room via the inlet that is controlled by a master. The fan speeds are switched as per the actual CO<sub>2</sub> level and the CO<sub>2</sub> setpoint.

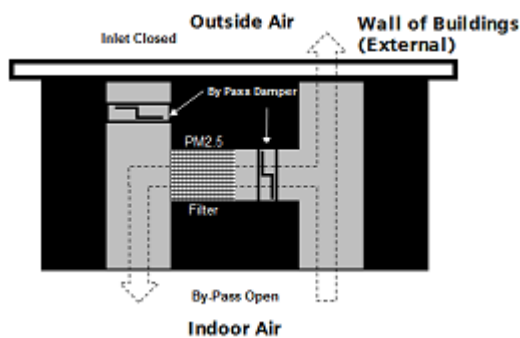

When the by-pass damper is active via control input from a master controller, the inlet is disabled by the master controller and outside air is blocked. As a result, all the exhaust air (or partially) will be forced to flow via the by-pass PM2.5 filter and return to the room – air circulates internally. The fan speeds are switched as per the actual PM2.5 level and the PM2.5 setpoint.

If both fans have same fan speed, airflow circulates internally. However, two fans also can be operated at different speeds to generate different air pressures internally.

Parameter mode user access

1. Touch & hold icon > 5 s



2. Enter first password via ◀ or ▶



PAS: Password



Factory: 00 00

3. Enter second password via ◀ or ▶



4. After 6 seconds

Note: Press the Setting icon to exit or re-enter the password if not correct



P: Successful login



F: Failed login

5. Edit parameters

Value of current selected parameter

Decrement or Previous available value

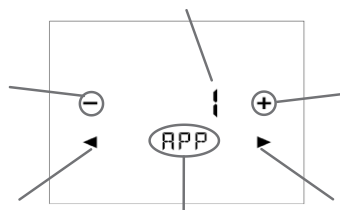

Increment or Next available value

Previous parameter

current selected Parameter

Next parameter

6. Exit parameter mode

Touch the setting mode icon to exit



NOTE:  
Passwords can be modified via both HMI and system.

## Engineering parameters

Item	Description	Range	Factory settings
MODA	Modbus address setting	1...247	1
MODB	Modbus baud rate setting	1: 9600 bps 2: 19200 bps 3: 38400 bps	2: 19200 bps
MODF	Modbus data frame format	0: 1/8/E/1 1: 1/8/O/1 2: 1/8/N/1 3: 1/8/N/2	0: 1/8/E/1
APP	Application selection	1: PM2.5 control only 2: PM2.5 + CO <sub>2</sub> control 3: CO <sub>2</sub> control only 4: Ventilation	1: PM2.5 control only
DISP	Symbol display enable/disable	0: Disable display 1: Enable display	1) Room temp= 1; 2) Outside temp= 0; 3) PM2.5= 1; 4) VOC= 0; 5) CO <sub>2</sub> = 0; 6) RH= 0;
SEN1 <sup>1)</sup>	External sensor1 type selection	0: No function 1: Temperature (AI) (NTC 10k) 2: Temperature (AI) (0...10 V) 3: PM2.5 (AI) µg/m <sup>3</sup> (0...10 V) 4: CO <sub>2</sub> (AI) ppm (0...10 V) 5: VOC (AI) % (0...10 V) 6: VOC (AI) mg/m <sup>3</sup> (0...10 V) 7: R.h. (AI) % (0...10 V) 8: Alarm input (DI) 9: Dummy AI (0...10 V) (RU only) 10: Dummy DI (RU only)	3: PM2.5 (AI) µg/m <sup>3</sup> (0...10 V)
DIL1	Control action if digital input	0: Normally open / Open 1: Normally closed / Closed	0: Normally open / Open
SEN2 <sup>1)</sup>	External sensor2 type selection	0: No function 1: Temperature (AI) (NTC 10k) 2: Temperature (AI) (0...10 V) 3: PM2.5 (AI) µg/m <sup>3</sup> (0...10 V) 4: CO <sub>2</sub> (AI) ppm (0...10 V) 5: VOC (AI) % (0...10 V) 6: VOC (AI) mg/m <sup>3</sup> (0...10 V) 7: R.h. (AI) % (0...10 V) 8: Alarm input (DI) 9: Dummy AI (0...10 V) (RU only) 10: Dummy DI (RU only)	0: No function
DIL2	Control action if digital input	0: Normally open / Open 1: Normally closed / Closed	0: Normally open / Open
PMH	PM2.5 sensor high range	Max. of low range...1000	500
PML	PM2.5 sensor low range	0...Min. of high range	0
CO2H	CO <sub>2</sub> sensor high range	Max. of low range...2000	2000
CO2L	CO <sub>2</sub> sensor low range	0...Min. of high range	0
UOCH	VOC sensor high range	Max. of low range...100	5
UOCL	VOC sensor low range	0...Min. of high range	0
HUMH	Humidity sensor high range	Max. of low range...100	100
HUML	Humidity sensor low range	0...Min. of high range	0

Item	Description	Range	Factory settings
TEMH	Temperature sensor high range	Max. of low range...100	50
TEML	Temperature sensor low range	-50...Min. of high range	0
SPMH	PM2.5 setpoint high range	Max. of low range...500	100
SPML	PM2.5 setpoint low range	0...Min. of high range	12
SPCH	CO <sub>2</sub> setpoint high range	Max. of low range...2000	1500
SPCL	CO <sub>2</sub> setpoint low range	0...Min. of high range	500
FAN	Fan type selection	1: 1 speed fan (ON/OFF) 3: 3 speed fan 4: 4 speed fan 5: ECM fan	3: 3 speed fan
ECMH	ECM fan output limit high	Max. of ECML...100 %	80 %
ECML	ECM fan output limit low	0...Min. of ECMH	30 %
TC	Filter time display setting	0: Disable 1: Enable	0: Disable
PMES <sup>2)</sup>	PM2.5 ECO mode setpoint	0...100	60
COES <sup>2)</sup>	CO <sub>2</sub> ECO mode setpoint	500... 1500	1000
BUZZ	Buzzer function	0: Disable 1: Enable	1: Enable
UNIT	Temperature unit	0: °C (degrees Celsius) 1: °F (degrees Fahrenheit)	0: °C (degrees Celsius)
LOCK	Keylock function	0: Unlock 1: Locked 2: Setpoint only 3: Operating mode only 4: Setpoint and fan speed only	0: Unlock
OPSL	Operating mode selection	0: ON/OFF 1: ON/ECO/OFF 2: ON/ECO/Protection/OFF (RU only) 3: ON/ECO/Protection (room unit only)	1: ON/ECO/OFF
CALT	Internal temperature sensor calibration	-5...5 K	0

RDF870KN available parameters and their order of appearance:

- Room controller:  
APP > DISP > SEN > FAN > OPSL > TC > UNIT > LOCK > BUZZ > CALT > APP

RDF870MB available parameters and their order of appearance:

- Room controller:  
MODA > MODB > MODF > APP > DISP > SEN > FAN > OPSL > TC > UNIT > LOCK > BUZZ > CALT > MODA
- Room unit:  
MODA > MODB > MODF > LOCK > BUZZ > CALT > MODA

<sup>1)</sup> Room controller: 0...8; Room unit: 0...10

<sup>2)</sup> The setpoint cannot be changed in ECO mode.

Restriction for sensor selection:

- If SEN1 and SEN2 are configured with same selection type 1...8, they cannot be the same sensor types:
  - For type 1...8, sensor1 cannot be the same as sensor2.
  - For sensor types with the same function such as 1&2 or 5&6, if one sensor type is 1 or 5, the other one cannot be 2 or 6.

Note:

When APP = 2 (both PM2.5 and CO<sub>2</sub> control) is selected, FAN = 1 or 3 only.

## Firmware setpoint settings

Item	Description	Range	Factory settings
TCSP	Filter time setting	0...9999	8760
PM2.5 SP	PM2.5 setpoint	SPML...SPMH	60
CO2 SP	CO <sub>2</sub> setpoint	SPCL...SPCH	1000
T SP	Temperature setpoint	T SP L...T SP H	24
T SP H	Temperature setpoint range high	Max. of low range...200 (°C)	50
T SP L	Temperature setpoint range low	-50...Min. of high range (°C)	5
VOC SP	VOC setpoint	%: 0...100 mg/m <sup>3</sup> : 0...5	0.6 mg/m <sup>3</sup> or 6 %
HUM SP	Humidity setpoint	0...100 %	50 %
P81 <sup>1)</sup>	Device address (KNX only)	1...255	255

<sup>1)</sup> P81 is only for ETS and local HMI does not support P81:

- During powering up, there is a startup delay ( $T_{waitDevice} = t_{waitMin} + DeviceAdr * 200ms$ ) before the processing signal is processed.
- When P81=255 (default), the device does not process the signal according to heartbeat and COV mechanism. But it can respond when another device is polling.
- The local HMI does not support P81.
- When individual address is changed via ETS, P81 is updated automatically after device downloads it from ETS.

## Expert mode parameters

Item	Description	Range	Factory settings
PMP	PM2.5 control factor Xp	0...1000	50
PMI	PM2.5 control factor Tn	0...120 min	45 min
CO2P	CO <sub>2</sub> control factor Xp	0...2000	100
CO2I	CO <sub>2</sub> control factor Tn	0...120 min	45 min
PMDB	PM2.5 control loop deadband	0...20	10
CODB	CO <sub>2</sub> control loop deadband	0...100	50
OPAF	Operating mode settings after power failure/reset	0: Return to previous operating mode / user setting 1: Off	0: Return to previous operating mode / user setting
FANT	Fan minimum on time	1...6 min	2 min
FSET	Reload factory settings	0: OFF = Disable 1: ON = Reload start “_”“_”“_”“_” is displayed while reloading	0: OFF = Disable
SW	Software version		
EPAS	Engineer mode password	0000...4999	0000
XPAS	Expert mode password	5000...9999	9999

Room controller workflow:

EPAS > XPAS > PMP > PMI > PMDB > CO2P > CO2I > CODB > OPAF > FANT > FSET > SW > EPAS

RDF870MB Room unit workflow: EPAS > XPAS > SW > EPAS

## Other parameters (RDF870MB room unit only)

Item	Description	Range	Factory settings
Output 1 (Q1)	Output for external Modbus controller (master)	0: Off 1: On	0: Off
Output 2 (Q2)	Output for external Modbus controller (master)	0: Off 1: On	0: Off
Output 3 (Q3)	Output for external Modbus controller (master)	0: Off 1: On	0: Off
Output 4 (Q4)	Output for external Modbus controller (master)	0: Off 1: On	0: Off

Overview

Object no. and name	RDF870...	Object no. and name
		➔ 8 Room operating mode: State
		➔ 9 Room operating mode: State Comfort
		➔ 10 Room operating mode: State Eco
		➔ 11 Room operating mode: State Protection
4 Room operating mode user: Preselection	↔	
5 Room operating mode user: Preselection Comfort	➔	
6 Room operating mode user: Preselection Eco	➔	
7 Room operating mode user: Preselection Protection	➔	
16 PM2.5 setpoint user	↔	➔ 18 PM2.5 current setpoint
17 CO <sub>2</sub> setpoint user	↔	➔ 19 CO <sub>2</sub> current setpoint
		➔ 20 X: Temperature
		➔ 21 X: Digital input [0/1]
13 Remote: Indoor temperature	➔	
15 Remote: Outdoor temperature	➔	
23 Remote: Humidity	➔	
28 Remote: PM2.5	➔	
29 Remote: CO <sub>2</sub>	➔	
30 Remote: VOC [mg/m <sup>3</sup> ]	➔	
31 Remote: VOC [%]	➔	
		➔ 12 Room temperature
		➔ 14 Outdoor temperature
		➔ 25 Room PM2.5
		➔ 24 Room CO <sub>2</sub>
		➔ 26 Room VOC [mg/m <sup>3</sup> ]
		➔ 27 Room VOC [%]
		➔ 22 Room humidity
		➔ 34 Fan operation (0= Auto/1=Manual)
33 Enable fan command value	➔	
32 Fan command user	➔	➔ 39 ECM fan output
		➔ 35 Fan speed 1 output
		➔ 36 Fan speed 2 output
		➔ 37 Fan speed 3 output
		➔ 38 Fan speed 4 output
3. Enable alarm info (Enable/Disable)	➔	➔ 1 Fault information
		➔ 2 Fault state (Normal/Faulty)

- ➔ Input communication object
- ➔ Output communication object
- ↔ Input and output communication object



## Description of communication objects

Object no.	Object name	Function	Type/length	Flags
1	<b>Fault information</b>	Alarm information	219.001 6 Byte	CT
Common alarm output. If an alarm occurs, the alarm number is transmitted.				
2	<b>Fault state</b>	Faulty/normal	1.005 1 bit	CT
Common alarm output. If an alarm occurs, the alarm flag is set.				
3	<b>Enable alarm info</b>	Enable/disable	1.003 1 bit	CWU
A supervisor alarm system can disable the broadcasting of alarms by the devices. This has no impact on the local display of alarms. After a timeout of 48 hours, the sending of faults is automatically enabled again.				
4	<b>Room operating mode user: Preselection</b>	Comfort Economy OFF	20.102 1 Byte	CWTU
Controls the room operating mode selection of the room controller/room unit via bus. The command can also be submitted as three 1-bit communication objects (5...7). The last interaction wins – either from local operating mode button or via bus. <b>Note:</b> 8-bit and 1-bit object available, selectable by using parameter in ETS				
5 6 7	<b>Operating mode user: Preselection</b> - Comfort - Eco - Protection	ON OFF	1.001 1 bit	CW
Switch room operating mode to either Comfort, Economy or OFF. The last interaction wins – either from local operating mode button or via bus. <b>Note:</b> 8-bit and 1-bit object available, selectable by using parameter in ETS				
8	<b>Room operating mode: State</b>	Comfort Economy Off	20.102 1 Byte	CRT
Effective room operating mode used by the thermostat (considering timer, user selection, etc.) This state information is available via one 8-bit enumeration or three 1-bit communication objects (9...11). <b>Note:</b> 8-bit and 1-bit object available, selectable by using parameter in ETS				
9 10 11	<b>Room operating mode:</b> - State Comfort - State Eco - State Protection	ON OFF	1.001 1 bit	CT
Corresponding communication object sends "True" <b>Note:</b> 8-bit and 1-bit object available, selectable by using parameter in ETS				
12	<b>Room temperature</b>	Temperature value	9.001 2 Bytes	CRT
Value of the room temperature. <b>Note:</b> The room temperature value is decided by priority if all value types exist. (Built in > Remote)				
13	<b>Remote: Indoor temperature</b>	Temperature value	9.001 2 Bytes	CWU
Remote indoor temperature sensor value				
14	<b>Outdoor temperature</b>	Temperature value	9.001 2 Bytes	CRT
Value of the outside temperature is received.				

Object no.	Object name	Function	Type/length	Flags
Note: Outside temperature value is decided by the priority order if all value types exist. (X1/X2 > Remote)				
15	<b>Remote: Outdoor temperature</b>	Temperature value	9.001 2 Bytes	CWU
Remote outside temperature sensor value				
16	<b>PM2.5 setpoint user</b>	AQ Setpoint value	9.030 2 Bytes	CWTU
One AQ setpoint value from a HMI. Same priority as local setpoint shift on the thermostat. The last intervention wins.				
17	<b>CO<sub>2</sub> setpoint user</b>	AQ Setpoint value	9.008 2 Bytes	CWTU
One AQ setpoint value from a HMI. Same priority as local setpoint shift on the thermostat. The last intervention wins.				
18	<b>PM2.5 current setpoint</b>	AQ Setpoint value	9.030 2 Bytes	CRT
Effective AQ setpoint, used for PM2.5 control.				
19	<b>CO<sub>2</sub> current setpoint</b>	AQ Setpoint value	9.008 2 Bytes	CRT
Effective AQ setpoint, used for CO <sub>2</sub> control.				
20	<b>X: Temperature</b>	Temperature value	9.001 2 Bytes	CRT
Indicate the values of the temperature sensors connected to the local inputs X1 / X2. Note: Available only when X1/X2 set as temperature.				
21	<b>X: Digital input</b>	ON OFF	1.001 1 bit	CRT
Indicate the status of the digital inputs (adjusted by parameters SEN / DIL) including considering of operating action. <b>Note:</b> Available only when X1/X2 set as Filter alarm input				
22	<b>Room humidity</b>	Humidity value	9.007 2 Bytes	CRT
Indicate the value of the room humidity value Note: Room humidity value, priority order is X1/X2 > Remote				
23	<b>Remote: Humidity</b>	Humidity value	9.007 2 Bytes	CWU
Remote humidity sensor value				
24	<b>Room CO<sub>2</sub></b>	Room AQ value	9.008 2 Bytes	CRT
Indicate the value of the room CO <sub>2</sub> value Note: Room CO <sub>2</sub> value, priority order is X1/X2 > Remote				
25	<b>Room PM2.5</b>	Room AQ value	9.030 2 Bytes	CRT
Indicate the value of room PM2.5 value <b>Note:</b> Room PM2.5 value, priority order is X1/X2 > Remote				
26	<b>Room VOC[mg/m<sup>3</sup>]</b>	Room AQ value	9.030 2 Bytes	CRT

Object no.	Object name	Function	Type/length	Flags
Indicate the value of the room VOC value Note: Room VOC value, priority order is X1/X2 > Remote				
27	<b>Room VOC[%]</b>	Room AQ value	5.004 2 Bytes	CRT
Indicate the value of the room VOC value <b>Note:</b> Room VOC value, priority order is X1/X2 > Remote				
28	<b>Remote: PM2.5</b>	AQ value	9.030 2 Bytes	CWU
Remote PM2.5 value				
29	<b>Remote: CO<sub>2</sub></b>	CO <sub>2</sub> value	9.008 2 Bytes	CWU
Remote CO <sub>2</sub> value				
30	<b>Remote: VOC[mg/m<sup>3</sup>]</b>	AQ value	9.030 2 Bytes	CWU
Remote VOC value				
31	<b>Remote: VOC[%]</b>	AQ value	5.004 2 Bytes	CWU
Remote VOC value				
32	<b>Fan command user</b>	0...100%	5.001 8 bit	CWU
The fan can be set to a specified speed by a KNX control unit when manual fan operation is enabled. <b>Note:</b> 1) Fan speed "0" is not supported by the thermostat and the fan speed will remain unchanged.				
33	<b>Enable fan command value</b>	Enable Disable	1.003 1 bit	CWU
Set fan mode to Auto (disable) or Manual (enable) by a KNX control unit. If Manual, the value received on Fan command value (32) will be used to command the fan speed. Default: Enable The last interaction wins – either from the local fan mode button or via bus.				
34	<b>Fan operation</b>	Auto Manual	1.011 1 bit	CRT
Indicates the fan operation mode: Auto (0) or Manual (1).				
35	<b>Fan speed 1 output</b>	ON	1.011 1 bit	CRT
36	<b>Fan speed 2 output</b>	OFF		
37	<b>Fan speed 3 output</b>			
38	<b>Fan speed 4 output</b>			
Indicate the state of the relay outputs				
39	<b>ECM fan output</b>	0...100%	5.001 8 bit	CRT
Indicates the current fan speed as a value 0...100% <b>Note:</b> Available only when ECM fan type been selected.				

Description of communication objects

Object no.	Object	Register Address (Decimal)	Object length (bytes)	Read only (RO) or Read/Write (RW)	Read		Write		Multi Register Group Identification	Special process	Default Value	Data Value Range
					Function code 0x03--Read Single Holding Register 0x04--Read RO Register	0x06--Write Single Holding Register						
1	Modbus address	40001	1	RW	0x03	0x06	1			1	1...247	
2	Modbus baudrate	40002	1	RW	0x03	0x06	1			2	1: 9600bps 2: 19200bps 3: 38400bps	
3	Modbus format	40003	1	RW	0x03	0x06	1			0	0: 1/8/E/1 1: 1/8/O/1 2: 1/8/N/1 3: 1/8/N/2	
4	Application	40004	1	RW	0x03	0x06	1			1	1: PM2.5 control only 2: PM2.5 + CO <sub>2</sub> control 3: CO <sub>2</sub> control only 4: Ventilation	
5	Room temperature symbol enable	40005	1	RW	0x03	0x06	1			1	0: Disable display 1: Enable display	
6	Outdoor temperature symbol enable	40006	1	RW	0x03	0x06	1			0	0: Disable display 1: Enable display	
7	PM2.5 symbol enable	40007	1	RW	0x03	0x06	1			1	0: Disable display 1: Enable display	
8	VOC symbol enable	40008	1	RW	0x03	0x06	1			0	0: Disable display 1: Enable display	
9	CO <sub>2</sub> symbol enable	40009	1	RW	0x03	0x06	1			0	0: Disable display 1: Enable display	
10	Humidity symbol enable	40010	1	RW	0x03	0x06	1			0	0: Disable display 1: Enable display	
11	Reserved 1	40011	1	RW	0x03	0x06	1			0	0...ffff	
12 <sup>1)</sup>	External sensor 1 type selection	40012	1	RW	0x03	0x06	1			3	0: (no function) 1: Temperature (AI) (NTC 10k) 2: Temperature (AI) (0...10 V) 3: PM2.5 (AI) (0...10 V) 4: CO <sub>2</sub> (AI) (0...10 V) 5: VOC (AI) % (0...10 V) 6: VOC (AI) mg/m <sup>3</sup> (0...10 V) 7: rH (AI) (0...10 V) 8: Alarm input (DI) 9: Dummy AI (0...10 V) (Room unit only) 10: Dummy DI (Room unit only)	
13 <sup>2)</sup>	External sensor 1 DI action	40013	1	RW	0x03	0x06	1			0	0: Normally open / Open 1: Normally closed / Close	

Object no.	Object	Register Address (Decimal)	Object length (bytes)	Read only (RO) or Read/Write (RW)	Read Write		Multi Register Group Identification	Special process	Default Value	Data Value Range
					0x03--Read Single Holding Register	0x04--Read RO Register				
14 <sup>1)</sup>	External sensor 2 type selection	40014	1	RW	0x03	0x06	1		0	0: (no function) 1: Temperature (AI) (NTC 10k) 2: Temperature (AI) (0...10 V) 3: PM2.5 (AI) (0...10 V) 4: CO <sub>2</sub> (AI) (0...10 V) 5: VOC (AI) % (0...10 V) 6: VOC (AI) mg/m <sup>3</sup> (0...10 V) 7: rH (AI) (0...10 V) 8: Alarm input (DI) 9: Dummy AI (0...10 V) (Room unit only) 10: Dummy DI (Room unit only)
15 <sup>3)</sup>	External sensor 2 DI action	40015	1	RW	0x03	0x06	1		0	0: Normally open / Open 1: Normally closed / Close
16 <sup>4)</sup>	Temperature range high	40016	1	RW	0x03	0x06	1	x100	50	Max. of low range...100
17 <sup>4)</sup>	Temperature range low	40017	1	RW	0x03	0x06	1	x100	0	-50...Min. of high range
18 <sup>4)</sup>	PM2.5 range high	40018	1	RW	0x03	0x06	1		500	Max. of low range...1000
19 <sup>4)</sup>	PM2.5 range low	40019	1	RW	0x03	0x06	1		0	0...Min. of high range
20 <sup>4)</sup>	CO <sub>2</sub> range high	40020	1	RW	0x03	0x06	1		2000	Max. of low range...2000
21 <sup>4)</sup>	CO <sub>2</sub> range low	40021	1	RW	0x03	0x06	1		0	0...Min. of high range
22 <sup>4)</sup>	VOC range high	40022	1	RW	0x03	0x06	1	x10 <sup>5)</sup>	5mg or 50 %	Max. of low range...100
23 <sup>4)</sup>	VOC range low	40023	1	RW	0x03	0x06	1		0	0...Min. of high range
24 <sup>4)</sup>	Humidity range high	40024	1	RW	0x03	0x06	1		100	Max. of low range...100
25 <sup>4)</sup>	Humidity range low	40025	1	RW	0x03	0x06	1		0	0...Min. of high range
26	Reserved 2	40026	1	RW	0x03	0x06	1		0	0...ffff
27	PM2.5 setpoint high range	40027	1	RW	0x03	0x06	1		100	Max. of low range...500
28	PM2.5 setpoint low range	40028	1	RW	0x03	0x06	1		12	0...Min. of high range
29	CO <sub>2</sub> setpoint high range	40029	1	RW	0x03	0x06	1		1500	Max. of low range...2000
30	CO <sub>2</sub> setpoint low range	40030	1	RW	0x03	0x06	1		500	0...Min. of high range
31	Fan type	40031	1	RW	0x03	0x06	1		3	1: On/Off fan 3: 3 speed fan 4: 4 speed fan 5: ECM fan
32	ECM fan output limit LOW	40032	1	RW	0x03	0x06	1		30	0...Min. of high range
33	ECM fan output limit HIGH	40033	1	RW	0x03	0x06	1		80	Max. of low range...100%
34	Filter time display setting	40034	1	RW	0x03	0x06	1		0	0: disable 1: enable

Object no.	Object	Register Address (Decimal)	Object length (bytes)	Read only (RO) or Read/Write (RW)	Read	Write	Multi Register Group Identification	Special process	Default Value	Data Value Range
					0x03--Read Single Holding Register	0x04--Read RO Register				
35 <sup>6)</sup>	PM2.5 ECO setpoint	40035	1	RW	0x03	0x06	1		60	0...100
36 <sup>6)</sup>	CO <sub>2</sub> ECO setpoint	40036	1	RW	0x03	0x06	1		1000	500...1500
37	Reserved 3	40037	1	RW	0x03	0x06	1		0	0...ffff
38	Buzzer	40038	1	RW	0x03	0x06	1		1	0: Disable 1: Enable
39	Temperature unit	40039	1	RW	0x03	0x06	1		0	0: °C (degrees Celsius) 1: °F (degrees Fahrenheit)
40 <sup>7)</sup>	Keylock	40040	1	RW	0x03	0x06	1		0	0: Unlock 1: Locked 2: Setpoint only 3: Operating mode only 4: Setpoint and fan speed only
41	Operation mode	40041	1	RW	0x03	0x06	1		1	0: ON/OFF 1: ON/ECO/OFF 2: ON/ECO/Protection/OFF (Room unit only) 3: ON/ECO/Protection (Room unit only)
42	Calibration internal T sensor	40042	1	RW	0x03	0x06	1	x100	0	-5...+5 in K
43	Reserved 4	40043	1	RW	0x03	0x06	1		0	0...ffff
44	PM2.5 factor Xp	40044	1	RW	0x03	0x06	1		50	0...1000
45	PM2.5 factor Tn	40045	1	RW	0x03	0x06	1		45	0...120 mins
46	PM2.5 deadband	40046	1	RW	0x03	0x06	1		10	0...20
47	CO <sub>2</sub> factor Xp	40047	1	RW	0x03	0x06	1		100	0...2000
48	CO <sub>2</sub> factor Tn	40048	1	RW	0x03	0x06	1		45	0...120 mins
49	CO <sub>2</sub> deadband	40049	1	RW	0x03	0x06	1		50	0...100
50	Reserved 5	40050	1	RW	0x03	0x06	1		0	0...ffff
51	Operation mode power failure	40051	1	RW	0x03	0x06	1		0	0: Return to previous operating mode / User setting 1: Off
52	Fan minimum on time	40052	1	RW	0x03	0x06	1		2	1...6
53	Reload factory setting	40053	1	RW	0x03	0x06	1		0	0=OFF: Disable 1=ON: Reload factory setting
54	Engineer mode password	40054	1	RW	0x03	0x06	1		0000	0000...4999
55	Expert mode password	40055	1	RW	0x03	0x06	1		9999	5000...9999
56	Reserved 6	40056	1	RW	0x03	0x06	1		0	0...ffff
57	Software version	30001	1	RO	0x04		4		-	0000...9999
58	Filter time counter setpoint	40100	1	RW	0x03	0x06	2		8760	0...9999

Object no.	Object	Register Address (Decimal)	Object length (bytes)	Read only (RO) or Read/Write (RW)	Read Write		Multi Register Group Identification	Special process	Default Value	Data Value Range
					0x03--Read Single Holding Register	0x04--Read RO Register				
59	PM2.5 setpoint	40101	1	RW	0x03	0x06	2		60	SPML...SPMH
60	CO <sub>2</sub> setpoint	40102	1	RW	0x03	0x06	2		1000	SPCL...SPCH
61	Local DO1	40103	1	RW	0x03	0x06	2		0	0: Off; 1: On
62	Local DO2	40104	1	RW	0x03	0x06	2		0	0: Off; 1: On
63	Local DO3	40105	1	RW	0x03	0x06	2		0	0: Off; 1: On
64	Local DO4	40106	1	RW	0x03	0x06	2		0	0: Off; 1: On
65	Room temperature source	40107	1	RW	0x03	0x06	2		1	0: Built in temperature; 1: Remote
66	Current working mode	40108	1	RW	0x03	0x06	2		1	0: OFF; 1: ON; 2: ECO; 3: Protection (Room unit only)
67	Model name	30002	1	RO	0x04		4		-	0: Modbus model; 1: KNX model
68	Model type	30003	1	RO	0x04		4		-	0: Room controller; 1: Room unit
69	Room temperature present value	30004	1	RO	0x04		4		-	
70	Outdoor temperature present value	30005	1	RO	0x04		4		-	
71	PM2.5 present value	30006	1	RO	0x04		4		-	
72	CO <sub>2</sub> present value	30007	1	RO	0x04		4		-	
73	VOC present value	30008	1	RO	0x04		4		-	
74	Humidity present value	30009	1	RO	0x04		4		-	
75	Alarm present value	30010	1	RO	0x04		4		-	0: No alarm; 1: Have alarm
76	Room temperature	30011	1	RO	0x04		4	x100	0	0...50 °C
77	Outdoor temperature	30012	1	RO	0x04		4	x100	0	-50...200 °C
78 <sup>B)</sup>	PM2.5_External	30013	1	RO	0x04		4		0	0...1000
79 <sup>B)</sup>	CO <sub>2</sub> _External	30014	1	RO	0x04		4		0	0...2000
80 <sup>B)</sup>	VOC_External	30015	1	RO	0x04		4		0	0...10 mg/m <sup>3</sup> ; 0...100 %
81 <sup>B)</sup>	Humidity_External	30016	1	RO	0x04		4		0	0...100 %
82 <sup>B)</sup>	Alarm_External	30017	1	RO	0x04		4		-	0: OPEN; 1: CLOSE; 2: Invalid
83	Dummy_DI_X1	30018	1	RO	0x04		4		-	0: OPEN; 1: CLOSE;

Object no.	Object	Register Address (Decimal)	Object length (bytes)	Read only (RO) or Read/Write (RW)	Read Write		Multi Register Group Identification	Special process	Default Value	Data Value Range
										2: Invalid
84	Dummy_DI_X2	30019	1	RO	0x04		4		-	0: OPEN; 1: CLOSE; 2: Invalid
85	Dummy_AI_X1	30020	1	RO	0x04		4	x1000	-	0...10 V value
86	Dummy_AI_X2	30021	1	RO	0x04		4	x1000	-	0...10 V value
87 <sup>8)</sup>	Room temperature_Remote	40109	1	RW	0x03	0x06	2	x100	0	-50...200 °C; Use 32767 as non-valid value
88 <sup>8)</sup>	Outdoor temperature_Remote	40110	1	RW	0x03	0x06	2	x100	0	-50...200 °C; Use 32767 as non-valid value
89 <sup>8)</sup>	PM2.5_Remote	40111	1	RW	0x03	0x06	2		0	0...1000; Use 32767 as non-valid value
90 <sup>8)</sup>	CO2_Remote	40112	1	RW	0x03	0x06	2		0	0...2000; Use 32767 as non-valid value
91 <sup>8)</sup>	VOC_Remote	40113	1	RW	0x03	0x06	2		0	x10 for 0.0...10.0 mg/m <sup>3</sup> plus 128, it means use 128...228 stand for 0.0...10.0 mg/m <sup>3</sup> ; 0...100 %; Use 0...100 to stand for 0...100 %; Use 127 as non-valid value
92 <sup>8)</sup>	Humidity_Remote	40114	1	RW	0x03	0x06	2		0	0...100 %; Use 127 as non-valid value
93	Fan1 speed	40115	1	RW	0x03	0x06	2		0	0...1 for 1 speed fan; 0...3 for 3 speed fan; 0...4 for 4 speed fan; 0...100 for ECM fan
94	Fan 1 status	40116	1	RW	0x03	0x06	2		0	0: Auto; 1: Manual
95	Fan 2 speed	40117	1	RW	0x03	0x06	2		0	0...1 for 1 speed fan; 0...3 for 3 speed fan; 0...4 for 4 speed fan; 0...100 for ECM fan
96	Fan 2 status	40118	1	RW	0x03	0x06	2		0	0: Auto; 1: Manual
97	Alarm value display	40119	1	RW	0x03	0x06	2		0	0: Disable If alarm value ≥1, user can define the error code display in RU.
98	Alarm information	30022	1	RO	0x04		4		0	0: No alarm; Any bit set to 1 means there is alarm or error defined as below: Bit0: KNX bus error; Bit1: KNX ADR error; Bit2: AL1;



Object no.	Object	Register Address (Decimal)	Object length (bytes)	Read/Write (RW)	Read/Write		Multi Register Group Identification	Special process	Default Value	Data Value Range
					Read	Write				
										Bit3: AL2; Bit4: Clean filter; Bit5: Built-in sensor error; Bit6: EEPROM error; Bit7: X1/X2 error
99	PM2.5 sensor status	30023	1	RO	0x04		4		0	0: Normal status; 1: Module error; 2: Communication error
100	External PM2.5 sensor module error	30024	1	RO	0x04		4		0	0: No error; 1: Error
101	External PM2.5 sensor communication error	30025	1	RO	0x04		4		0	0: No error; 1: Error
102	Reserved	30026					4		0	0...ffff
103	Clean filter reminder	30027	1	RO	0x04		4		0	0: No reminder; 1: Reminder
104	Internal sensor error	30028	1	RO	0x04		4		0	0: No error; 1: Error
105	EEPROM error	30029	1	RO	0x04		4		0	0: No error; 1: Error
106	Filter counter value	30030	1	RO	0x04		4		0	0...9999
107	Room temperature setpoint	40200	1	RW	0x03	0x06	3	x100	24	Temp SP L...Temp SP H
108	VOC setpoint	40201	1	RW	0x03	0x06	3		0.6	x10 for 0.0...5.0 mg/m <sup>3</sup> ; 0...100 for %
109	Humidity setpoint	40202	1	RW	0x03	0x06	3		50	0...100 %
110	Temp SP H	40203	1	RW	0x03	0x06	3	x100	50	Max. of low range...200
111	Temp SP L	40204	1	RW	0x03	0x06	3	x100	5	-50...Min. of high range
112	Idle page display	40205	1	RW	0x03	0x06	3		3	0: --- (no function or no any configured function available) 1: Room temperature value 2: Outside temperature value 3: PM2.5 value 4: CO <sub>2</sub> value 5: VOC value 6: Relative humidity value
113	Function selection for room temperature	40206	1	RW	0x03	0x06	3		2	0: Disable 1: Enable without setpoint 2: Enable with setpoint
114	Function selection for outside temperature	40207	1	RW	0x03	0x06	3		1	0: Disable 1: Enable
115	Function selection for PM2.5	40208	1	RW	0x03	0x06	3		0	0: Disable 1: Enable without setpoint

Object no.	Object	Register Address (Decimal)	Object length (bytes)	Read only (RO) or Read/Write (RW)	Read Write		Multi Register Group Identification	Special process	Default Value	Data Value Range
										2: Enable with setpoint
116	Function selection for VOC	40209	1	RW	0x03	0x06	3		0	0: Disable 1: Enable without setpoint 2: Enable with setpoint
117	Function selection for CO <sub>2</sub>	40210	1	RW	0x03	0x06	3		0	0: Disable 1: Enable without setpoint 2: Enable with setpoint
118	Function selection for humidity	40211	1	RW	0x03	0x06	3		0	0: Disable 1: Enable without setpoint 2: Enable with setpoint
119	Function selection for FAN	40212	1	RW	0x03	0x06	3		1	0: Disable 1: 1 Fan 2: 2 Fan
120	Heating / Cooling / Ventilation status display	40213	1	RW	0x03	0x06	3		0	0: Disable 1: Heating only 2: Cooling only 3: Ventilation 4: Aux heating

1) If SEN1 and SEN2 are configured with the same selection type 1...8, they cannot be the same sensor types:

- For type 1...8, sensor1 cannot be the same as sensor2.
- For sensor types with the same function such as 1&2 or 5&6, if one sensor type is 1 or 5, the other one cannot be 2 or 6.

2) Displays only when SEN1 is set to DI

3) Displays only when SEN2 is set to DI

4) Depends on settings of SEN1 and SEN2

5) Only for unit µg/m<sup>3</sup>

6) The setpoint cannot be changed in ECO mode.

7) When the value is 0, the lock icon is not displayed. When other values are selected, the icon is displayed.

8) The difference between external and remote:

- Object name with external indicates the status, values of the connected sensors via inputs X1, X2, M.
- Object name with remote indicates the values received from master controller.
- If the values from master controller, external sensors and built-in sensor exist simultaneously, display priority of value on device is master controller > external sensors > built-in sensor.

Dimensions (mm)

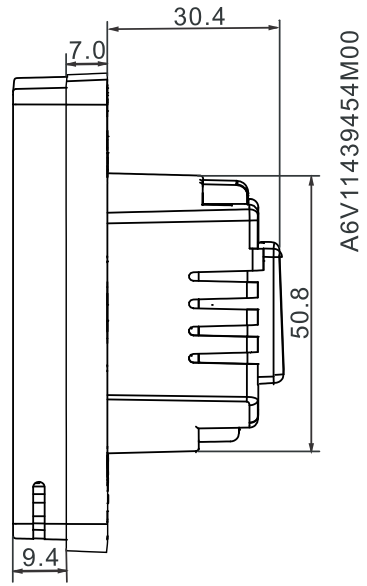
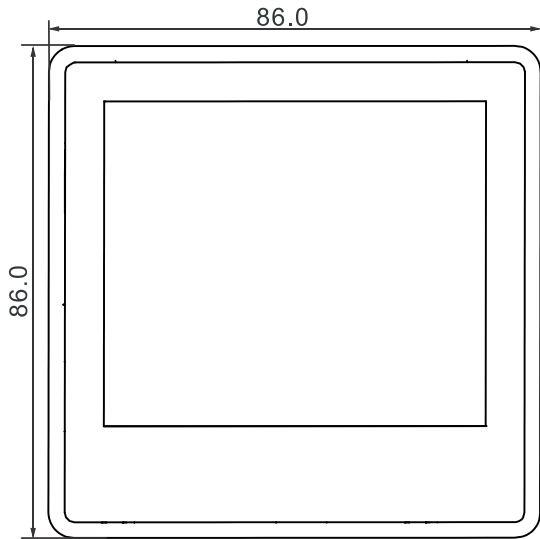

A6V11439454M00

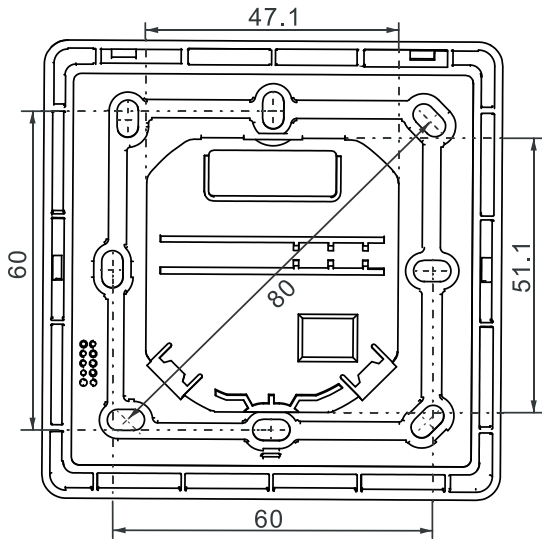
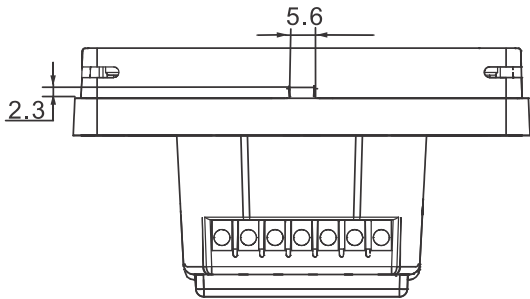

Issued by  
Siemens Switzerland Ltd  
Smart Infrastructure  
Global Headquarters  
Theilerstrasse 1a  
CH-6300 Zug  
+41 58 724 2424  
[www.siemens.com/buildingtechnologies](http://www.siemens.com/buildingtechnologies)

© Siemens Switzerland Ltd, 2019  
Technical specifications and availability subject to change without notice.

---

Document ID    A6V11439454\_en--\_d  
Edition        2021-03-31